

DRAWING	X	X.X	X.XX	X.XXX	ANGLE
TOLERANCE	±0.2	±0.1	±0.08	±0.01	±2°

품번 No	부품명 PART NAME	수량 Q'TY	재질 MATERIAL	색상 COLOR	처리 FINISH	비고 REMARK
01	HOUSING	1	Thermoplastic	BLACK		UL94V-0
02	GROUND	1	Copper Alloy	SILVER	Ag plated	
03	CONTACT A	1	Copper Alloy	SILVER	Ag plated	
04	CONTACT B	1	Copper Alloy	SILVER	Ag plated	

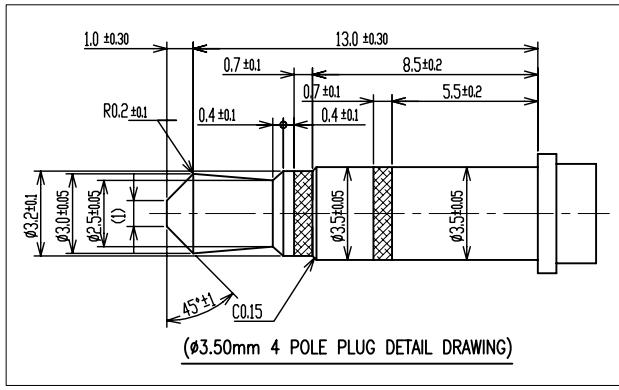
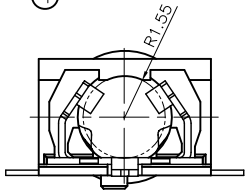
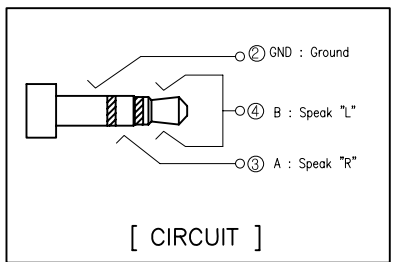
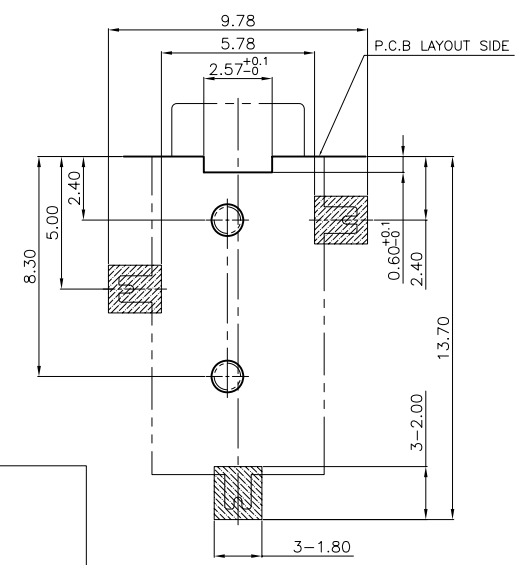
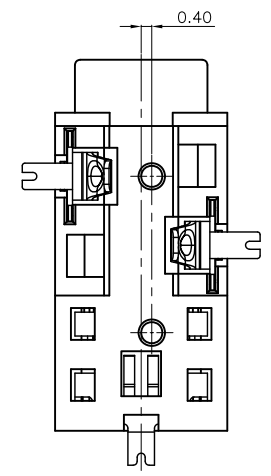
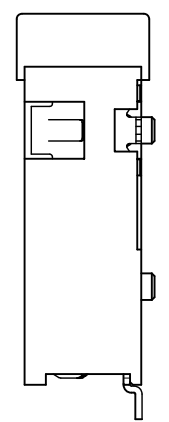
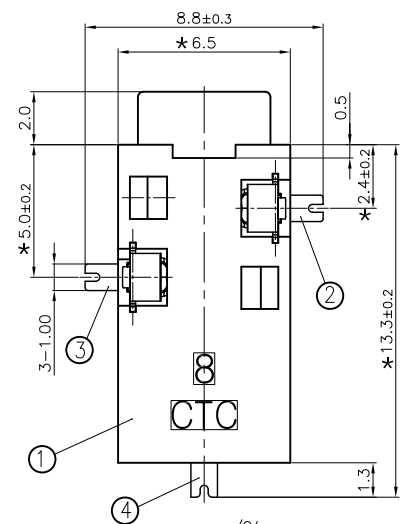
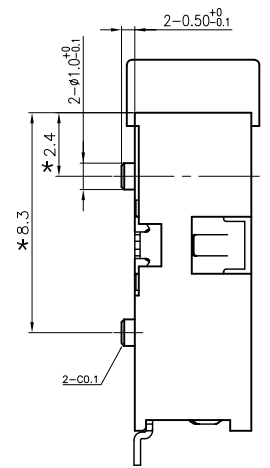
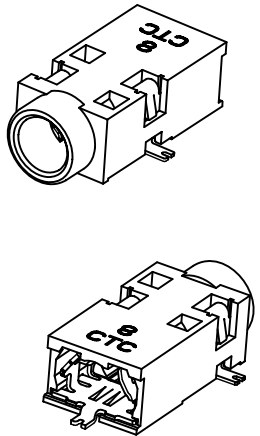
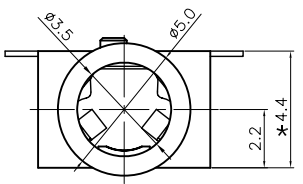

[Recommended P.C.B Pattern]

△					설계 DES'N BY	검토 CH'D BY	승인 APPROVE BY	작성일자 DWG DATE	08.05.28	모델명 MODEL NAME	ø3.5 EAR PHONE JACK 3 POLE	
△								척도 SCALE	1 / 1	부품명 PART NAME	7630 ASSEMBLY	
△								단위 UNITS	mm	도번 DWG NO	제품규격 STANDARD 7630-3.5S-SB2-A	
△											제품코드 ERP CODE	
No	내	용	작성일	작성자	승인	Connection Technologies Corporation						