

DRAWING	X	X.X	X.XX	X.XXX	ANGLE
TOLERANCE	±0.2	±0.1	±0.08	±0.01	±2°

ROHS H/F

품번 No	부품명 PART NAME	수량 Q'TY	재질 MATERIAL	색상 COLOR	처리 FINISH	비고 REMARK
01	HOUSING	1	Thermoplastic	BLACK		HB
02	GROUND	1	Copper Alloy	SILVER	Ag plated	
03	CONTACT A	1	Copper Alloy	SILVER	Ag plated	
04	CONTACT B	1	Copper Alloy	SILVER	Ag plated	

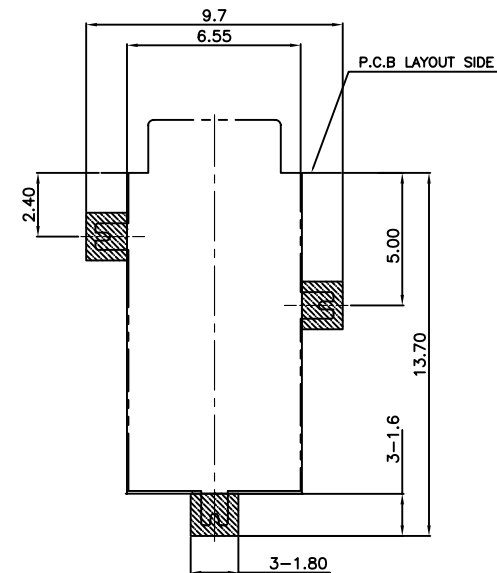
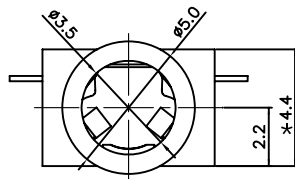
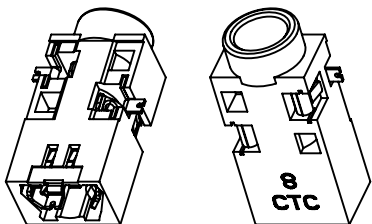

[Recommended P.C.B Pattern]

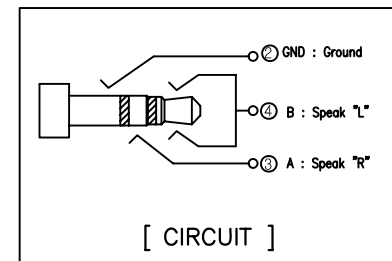

[CIRCUIT]

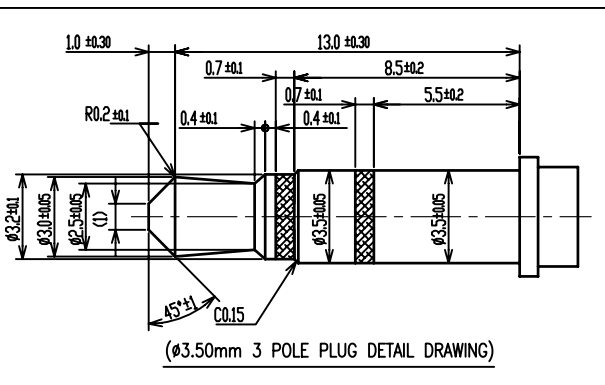
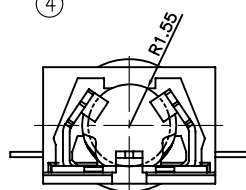
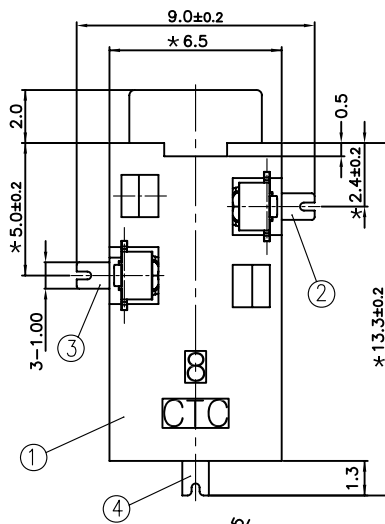

($\phi 3.50\text{mm}$ 3 POLE PLUG DETAIL DRAWING)

△					설계 DES'N BY	검도 CH'D BY	승인 APPROVE BY	작성 일자 DWG DATE	09.02.20	모델명 MODEL NAME	$\phi 3.5$ EAR PHONE JACK 3 POLE		
△								척도 SCALE	1 / 1	부품명 PART NAME	7630 ASSEMBLY	제품 규격 STANDARD	7630-3.5S-SB0-D
△								단위 UNITS	mm	도번 DWG NO	IS179A043A	제품 코드 ERP CODE	
No	내	용	작성 일	작성자	승인	CTC Connection Technologies Corporation							