

DRAWING	X	X.X	X.XX	X.XXX	ANGLE
TOLERANCE	±0.1	±0.08	±0.05	±0.01	±1°

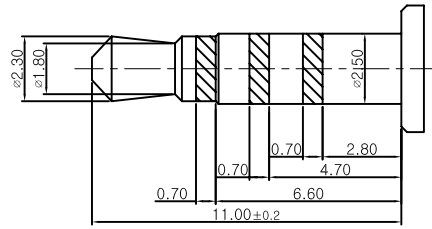

4POLE PLUG SPECIFICATION

품번	부품명	수량	재질	색상	처리	비고
No	PART NAME	Q'TY	MATERIAL	COLOR	FINISH	REMARK
01	7609 GROUND	1	Copper Alloy	GOLD	GOLD FLASH	
02	7609 CONTACT G2	1	Copper Alloy	GOLD	GOLD FLASH	
03	7609 CONTACT G1	1	Copper Alloy	GOLD	GOLD FLASH	
04	7609 CONTACT B	1	Copper Alloy	GOLD	GOLD FLASH	
05	7609 SWITCH	1	Copper Alloy	GOLD	GOLD FLASH	
06	7609 DUMMY	1	Copper Alloy	GOLD	GOLD FLASH	
07	7609 HOUSING	1	PA-9T	BLACK		UL94V-0

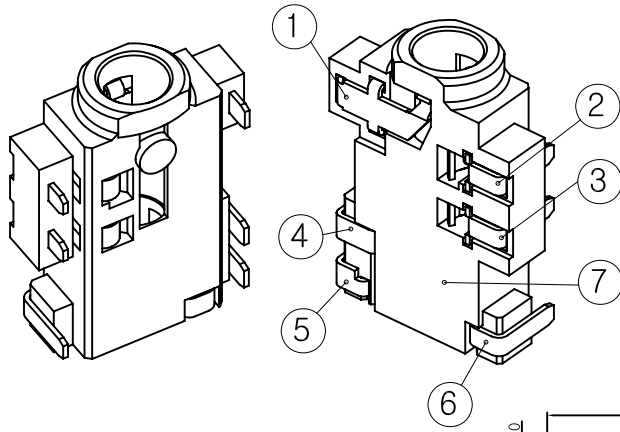
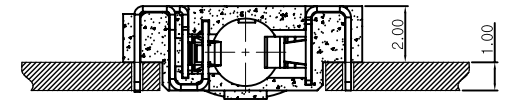
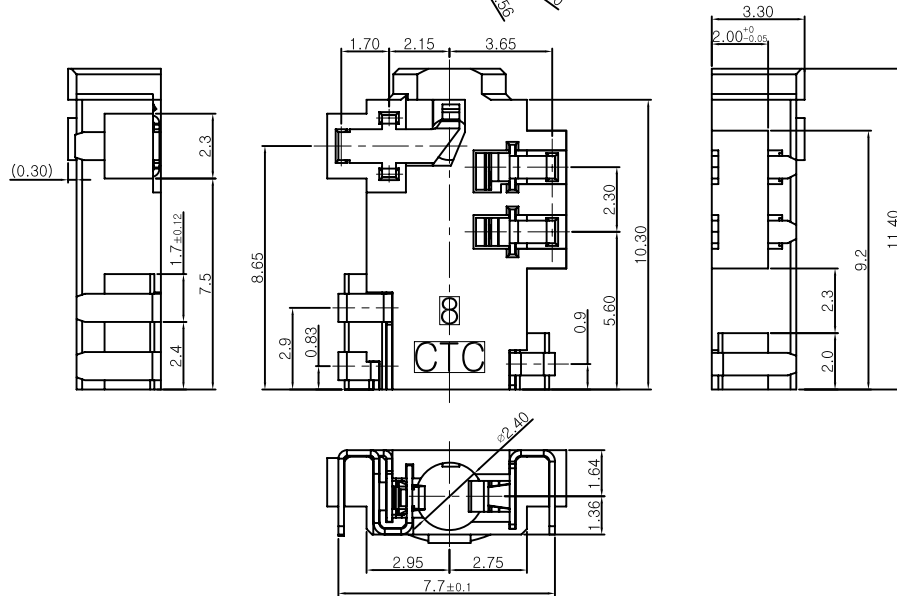
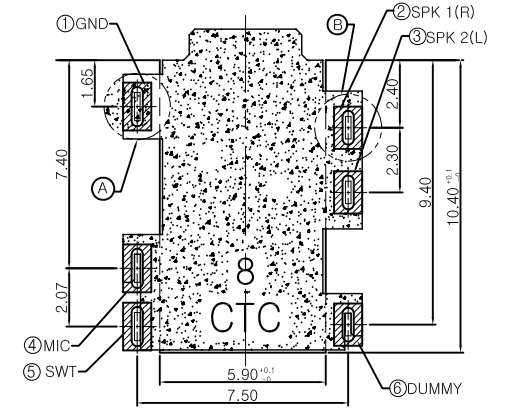
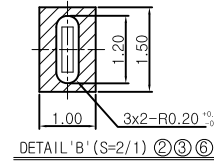
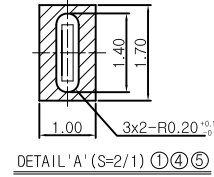
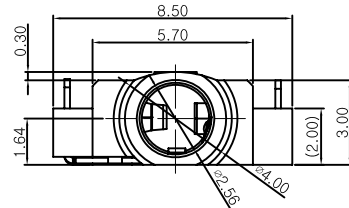

DETAIL OF PRODUCT PATTERN

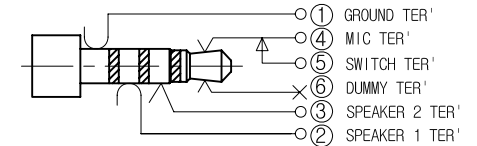

SCHMATIC

△					설계	검도	승인	작성 일자	모델명	
△					DES'N BY	CH'D BY	APPROVE BY	DWG DATE	MODEL NAME	
△					Y.H.S		M.C.H	06.01.06	EAR PHONE JACK 4 POLE	
△					COPLANARITY 삭제			척도	부품명	
△					08.03.14	Y.H.S		SCALE	PART NAME	
△					07.09.14	Y.H.S	C.H.M	1/1	7609 ASSEMBLY	
△					도면 치수 정정.			단위	제품 규격	
△								UNITS	STANDARD	
No	내	용	작성일	작성자	승인	CTC Connection Technologies Corporation		mm	도번	7609-2.5G-DB1-A
									DWG NO	IS131A013A
									제품 코드	PE4XX360
									ERP CODE	